



EB-S

Battery driven
torque multiplier

The new EB – Extreme Flexibility

Applications

- **alkitronic® EB:** Battery-driven torque multiplier from 170 Nm to 6,000 Nm / 125 ft.lbs to 4,425 ft.lbs.
- **Extremely mobile and always ready for use:** Innovative product design for comfortable working - independent of external power supply.
- **Permanent higher joint quality** by continuous rotation of the square drive.

Advantages

- **Ergonomic design:** Ultra grippy housing for your safety and a secure bolting procedure.
- **OLED-display:** Anti-glare and high contrast – for perfect reading under all weather conditions.
- **High quality bolting:** The brushless synchronous motor with excellent efficiency and the smart processor-controlled automatic shutdown ensures amazing increased productivity and **low** running costs.
- **Low noise emissions, no noise protection necessary.**
- **alkitronic® smart service:** Enabling wireless documentation and information.
- **Unique 1-finger trigger:** Unbeatable efficiency through fast, simple change of direction of rotation.
- **Maximum flexibility:** Thanks to the application-specific, modular software packages from **alkitronic®** - e.g. bolting according to the torque/rotation angle method with adjustable min./max. torque limitation. Can also be retrofitted later if the bolting application changes.
- **Repeat shut-off accuracy $\pm 3\%$** for the same bolting application.

alkitronic® specials

- **Simple navigation:** Intuitive interface drastically reduces operating errors and misadjustments.
- **Health and safety first:** Due to a new technology patented by **alkitronic®** the reaction torques are decoupled. This leads to an extreme reduction of radial forces on the wrist to 1 Nm and thus actively contributes to the occupational health and safety of the worker.
- **Outstanding battery concept:** Vast increase in operating time thanks to innovative switching from 4 to 6 Ah.



Bolting programs

The software suite 1 is pre-installed in the basic equipment. For user-specific applications, the manufacturer can activate optional modular software:

Software suite 1: Torque controlled bolting (standard)

Software suite 2: Torque/angle procedure for high-quality bolting connections

Software suite 2

Premium: Torque/angle procedure with adjustable min./max. torque limitation

Software suite 3: Bolting with preset rotations and torque limit

Software suite 4: Customised increment modification

Software suite 5: Bluetooth transmission via **alkitronic® APP**.

Documentation of the bolted joints (target-actual status, recording for each joint)

Specifications

All **alkitronic® EB** torque multipliers with CE-certification.

Caution! The Li-Ion battery is preset to 4 Ah (72 Wh) so that it can be shipped or transported in accordance with special regulation 188.

Operating panel

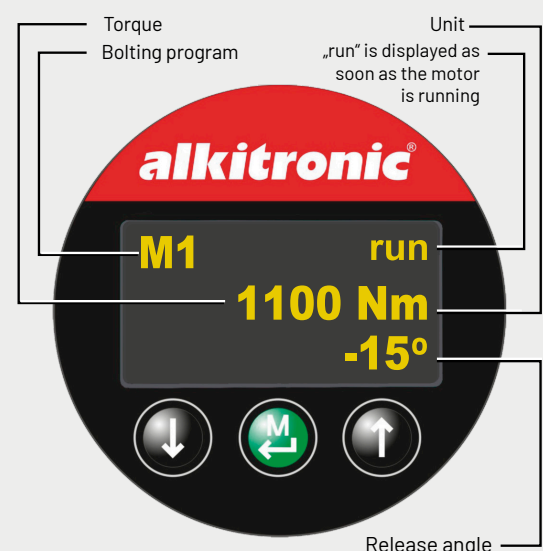

alkitronic® EB-S battery driven torque multiplier

Technical Data

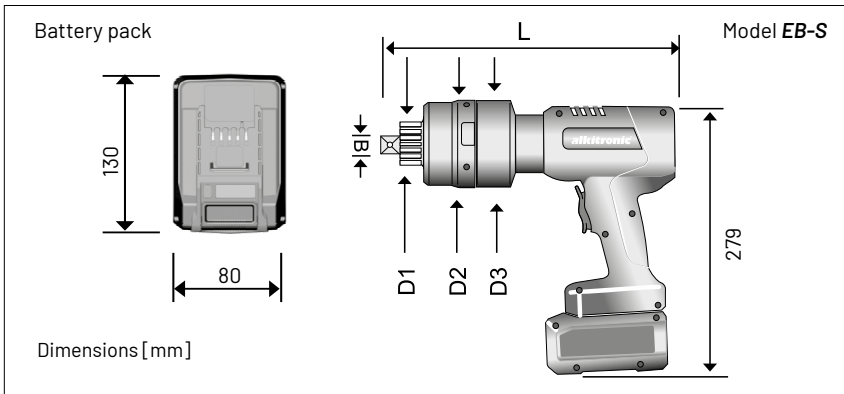

alkitronic® DMA
Topology-optimised construction: very light and yet stable.



Models EB-S

Type		EB-S 80	EB-S 150	EB-S 180	EB-S 250	EB-S 350	EB-S 480	EB-S 600
Torque ranges (approx.)*	Nm	170-850	280-1400	360-1800	500-2500	700-3500	960-4800	1200-6000
	ft.lbs	125-625	205-1035	265-1330	365-1845	515-2580	705-3540	885-4425
Square drive	B	3/4"	3/4"	1"	1"	1"	1 1/2"	1 1/2"
Diameter (approx.)	D ₁	mm	41	41	41	54	54	72
Diameter (approx.)	D ₂	mm	88	88	88	88	88	109
Diameter (approx.)	D ₃	mm	88	88	88	88	88	88
Length (approx.)	L	mm	330	330	375	382	382	400
Weight without DMA** (approx.)		kg	6.2	6.2	7.7	8.3	8.3	10.3

*) When loosening bolts, a higher torque (up to 20 %) may be necessary (release torque). We will be pleased to help you with your choice. **) Torque reaction arm



Display views

Software suite 1 (mode 1) and software suite 2 (mode 2)

Mode 1 / M1 (Standard)

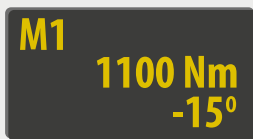

Bolting via torque.
Automatic release according to pre-set angle degrees.

Mode 2 / M2 (Option)

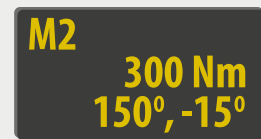

Torque/angle procedure for high-quality bolting connections.
Display example of pre-torque, angle and release angle.

During the bolting process, the current torque value is shown in the display. Reaching the set value is indicated by an "OK". If the selected value cannot be achieved, the bolting operation is evaluated as "nOK".

Scheme bolting programs Mode 1 und Mode 2

Torque controlled bolting mode 1

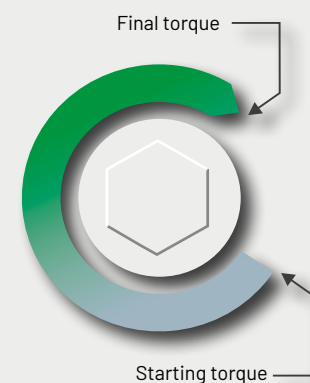

Torque/angle procedure mode 2

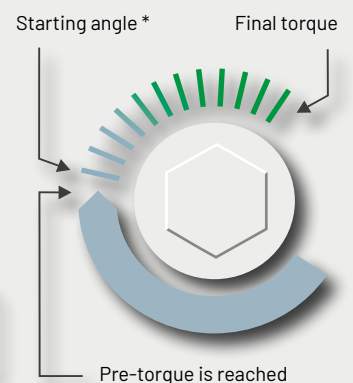

* Information on rotational angle setting for torque/angle method.

- The angle of rotation is specified by the design for the bolting connection.
- The angle of rotation can be determined individually and easily with **alkitronic® HSD**. We will gladly provide you with detailed product information.

YOUR PLUS FOR MORE PERFORMANCE

Increased quality

Premium production
Highest quality materials
Long product life cycles
Experience in bolting technology since 1984
Made in Germany – international patents

Increased precision

Precise, customer-specific torques
High repeatability
Reliability in permanent operation
Documentation of tightening results
Automatic shut-off

Increased productivity

Quicker tightening without reworking
No environmentally caused failures (IP54, ATEX)
High work safety
Easy to use: clear, simple instructions
Low maintenance and cost efficient

Better service

Technical advice on site
Training offers
Manufacturer's calibration and certification
Lifecycle support
Spare part and repair service

alki TECHNIK GmbH

Development, Production and Distribution of Bolting Systems

Unterlettenweg 4 – 85051 Ingolstadt/Germany – fon +49 841 97499-0 – fax +49 841 97499-90
info@alkitronic.com – www.alkitronic.com

EXTRACT FROM OUR PRODUCT RANGE



alkitronic XE-SERIES

THE ELECTRICS



alkitronic XP-SERIES

THE PNEUMATICS

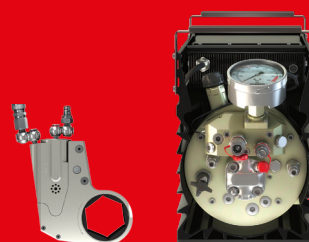

alkitronic XH-SERIES

THE HYDRAULICS



alkitronic XM-SERIES

THE MANUALS